

# FIRMAMENTO 18

MATERASSO SPESSORE 18 CM PROFONDITÀ 195 CM  
MATTRESS THICKNESS 18 CM DEPTH 195 CM

## BRACCIOLO/ARMREST ERCOLE 20 CM

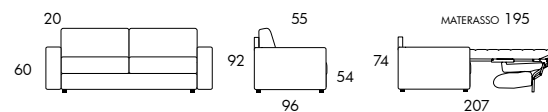
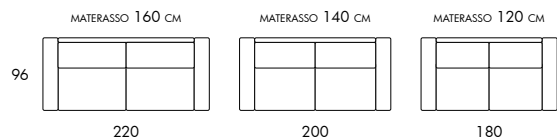

## BRACCIOLO/ARMREST AURIGA 17 CM

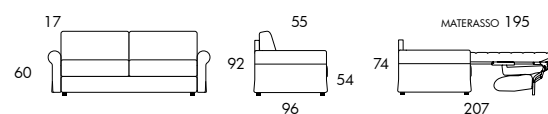
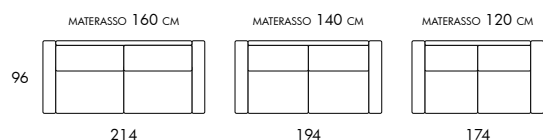

## BRACCIOLO/ARMREST DORADO 15 CM

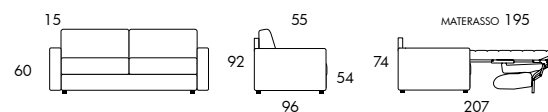
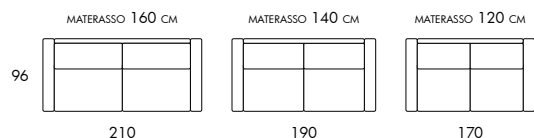

## BRACCIOLO/ARMREST LIRA 10 CM

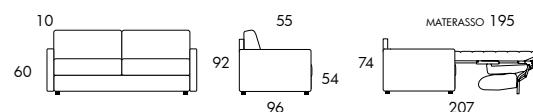
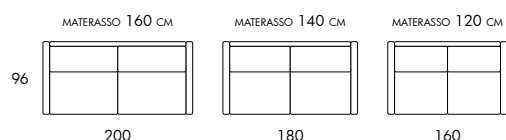

CUSCINO 50 x 50 CM  
CUSHION 50 x 50 CM



CUSCINO 60 x 30 CM  
CUSHION 60 x 30 CM



RISPETTO A "FIRMAMENTO" LE ALTEZZE VARIANO DI 7 CM - PER QUESTO MODELLO NON È DISPONIBILE LA VERSIONE COMBINIBILE  
COMPARED TO "FIRMAMENTO" THE HEIGHTS INCREASES OF 7 CM - FOR THIS MODEL THE COMPOSITION VERSION IS NOT AVAILABLE

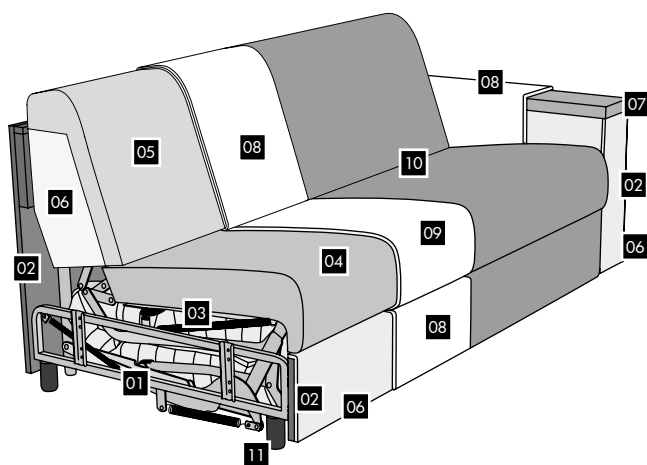

01. Struttura di acciaio ad alta resistenza con vernice protettiva di polveri epossidiche ~ High-strength steel structure with protective epoxy paint
02. Pannelli di particelle di pioppo, pannelli di stratificato di abete, massello di abete ~ Poplar chipboard wood, fir plywood, fir wood
03. Sostegno della seduta in rete elettro-saldata di acciaio ~ Seats supported by electro-welded steel net
04. PU espanso ds 30 kg/mc elastico ~ Elastic PU foam ds 30 kg/mc
05. PU espanso ds 25 kg/mc elastico ~ Elastic PU foam ds 25 kg/mc
06. PU espanso ds 21 kg/mc ~ PU foam ds 21 kg/mc
07. PU espanso ds 40 kg/mc elastico ~ Elastic PU foam ds 40 kg/mc
08. Fibra di PL da 150 gr termolegata a tessuto indemagliabile bianco ~ 150 gr PL fiber thermally coupled to white ladderproof fabric
09. Fibra di PL da 300 gr termolegata a fibra di PL agugliata ~ 300 gr PL fiber thermally coupled PL fiber needle-punched
10. Rivestimento ~ Cover
11. Piedi di faggio tinti noce medio, alto 8 cm ~ Feet made of beech stained walnut, 8 cm high.

SFODERABILITÀ: in tessuto ed ecopelle è completamente sfoderabile. In pelle è parzialmente sfoderabile.  
NOTE: poliuretano espanso privo di CFC.

COVER: completely removable in fabric and ecoleather. Leather cover is partially removable.  
NOTES: CFC-free polyurethane foam.