

FIRMAMENTO

DI SERIE MATERASSO DI POLIURETANO SPESSORE 14 CM PROFONDITÀ 195 CM
AS STANDARD POLYURETHANE MATTRESS THICKNESS 14 CM DEPTH 195 CM

BRACCIOLO/ARMREST ERCOLE 20 CM

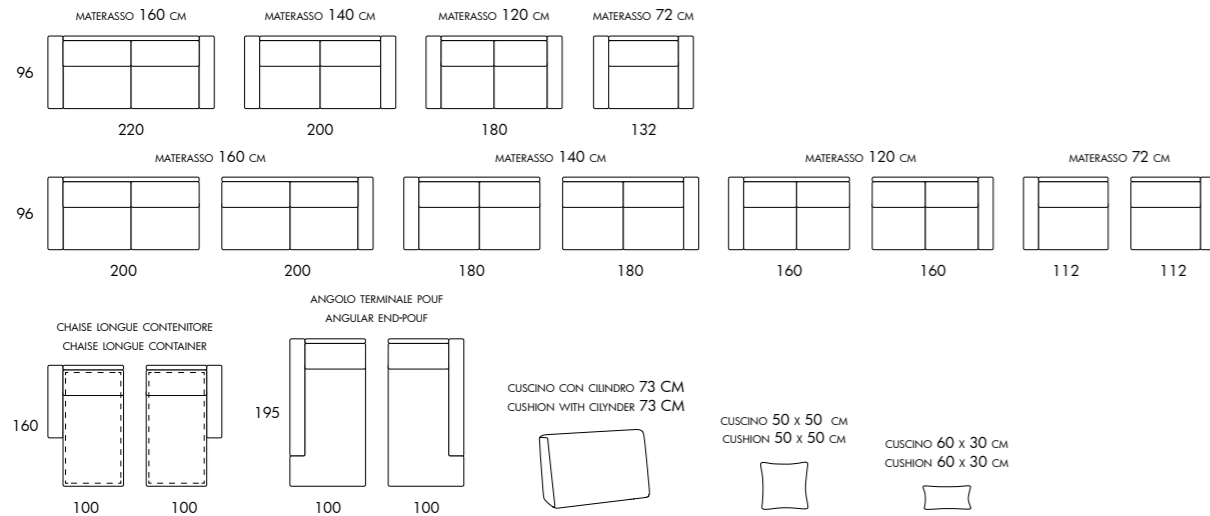
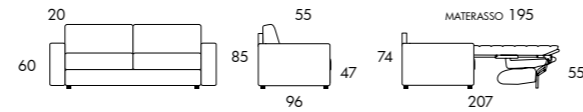

BRACCIOLO/ARMREST AURIGA 17 CM

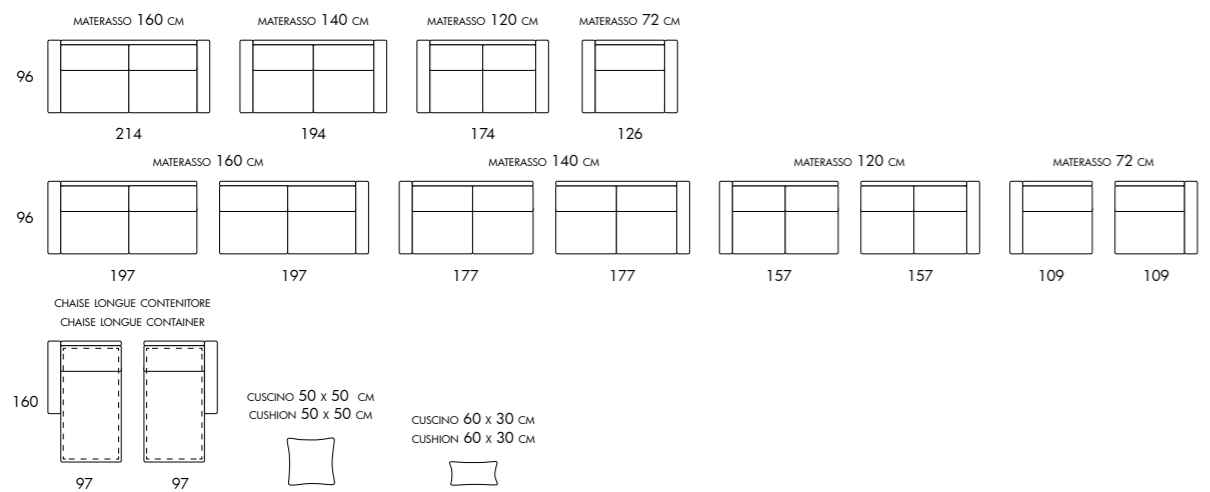
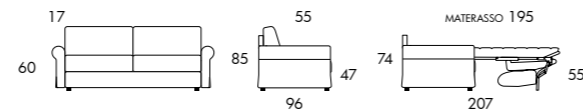

BRACCIOLO/ARMREST FENICE 17 CM

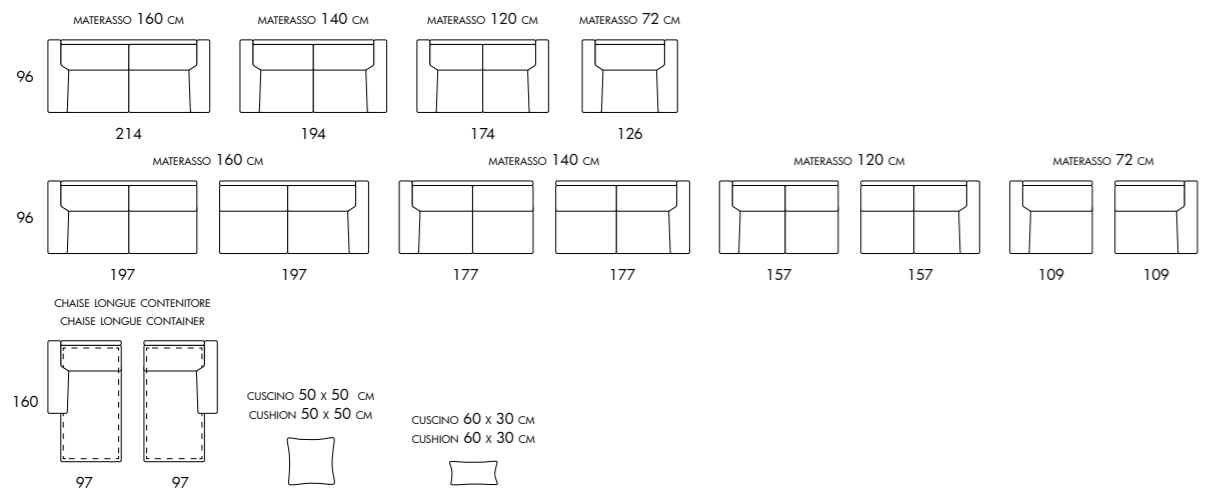
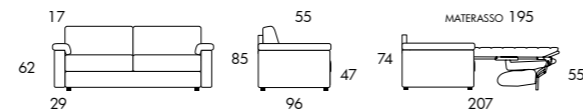

BRACCIOLO/ARMREST DORADO 15 CM

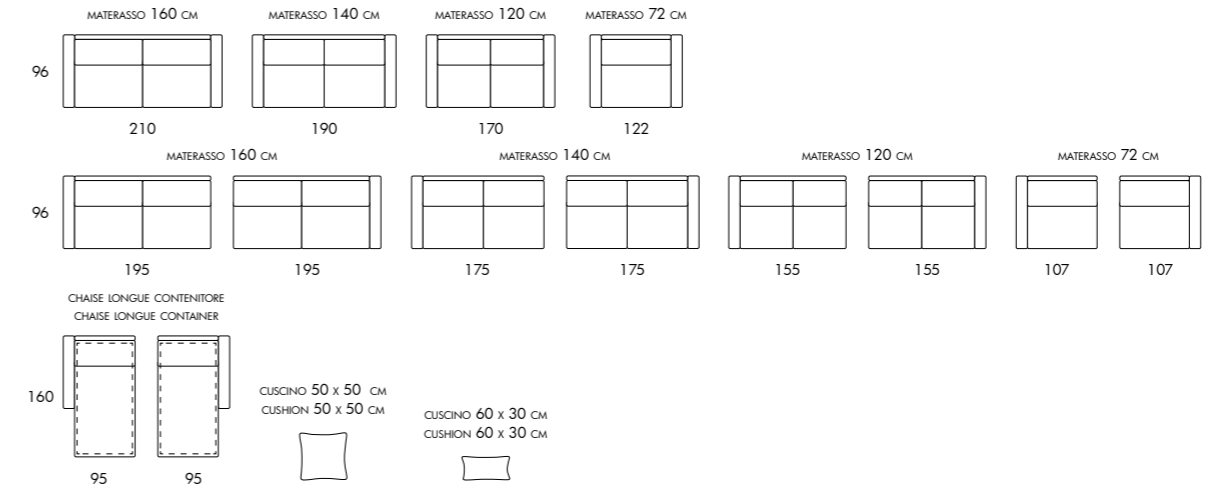
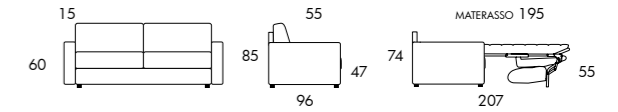

BRACCIOLO/ARMREST LIRA 10 CM

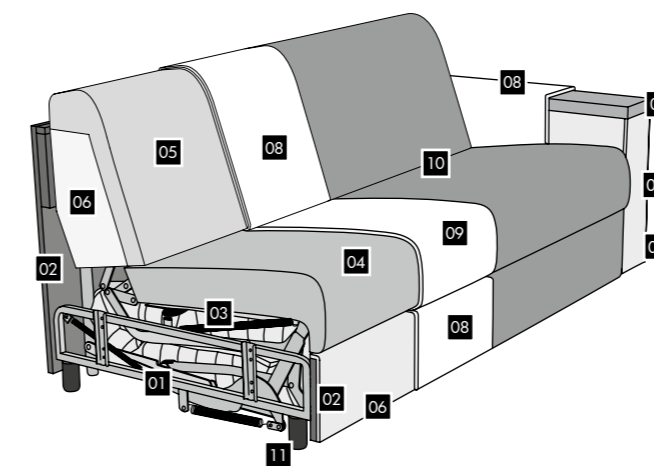
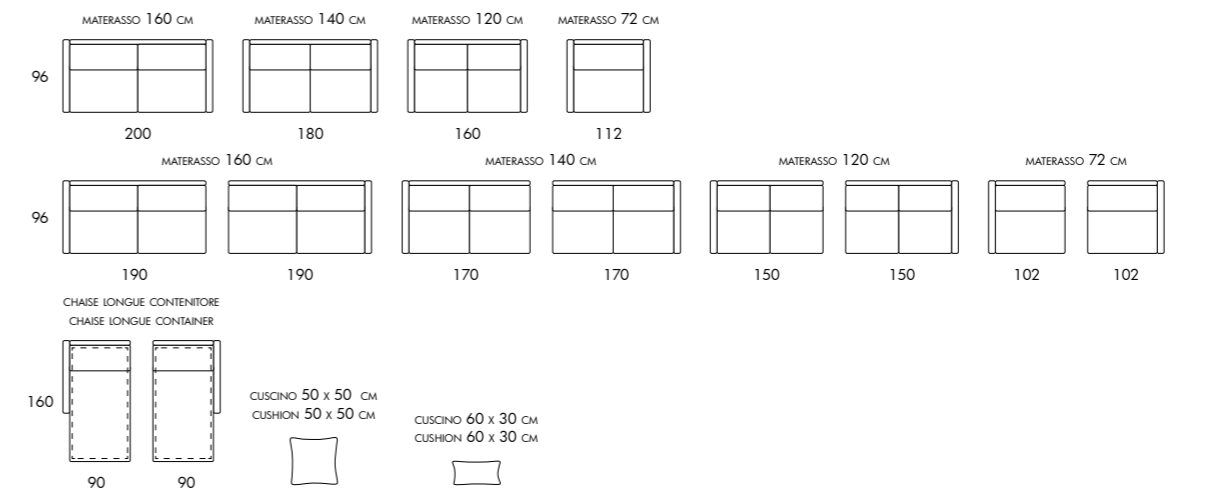
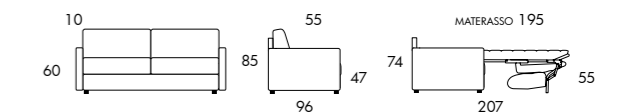

01. Struttura di acciaio ad alta resistenza con vernice protettiva di polveri epossidiche ~ High-strength steel structure with protective epoxy paint
02. Pannelli di particelle di pino, pannelli di stratificato di abete, massello di abete ~ Pine particle board, fir plywood, fir wood
03. Sostegno della seduta in rete elettrosaldata di acciaio ~ Seats supported by electro-welded steel net
04. PU espanso ds 30 kg/mc elastico ~ Elastic PU foam ds 30 kg/mc
05. PU espanso ds 25 kg/mc elastico ~ Elastic PU foam ds 25 kg/mc
06. PU espanso ds 21 kg/mc ~ PU foam ds 21 kg/mc
07. PU espanso ds 40 kg/mc elastico ~ Elastic PU foam ds 40 kg/mc
08. Fibra di PL da 150 gr termolegata a tessuto indemagliabile bianco ~ 150 gr PL fiber thermally coupled to white ladderproof fabric
09. Fibra di PL da 300 gr termolegata a fibra di PL agugliata ~ 300 gr PL fiber thermally coupled PL fiber needle-punched
10. Rivestimento ~ Cover
11. Piedi di faggio tinti noce medio, alto 8 cm ~ Feet made of beech stained walnut, 8 cm high.

COMPONIBILITÀ: gli elementi vengono uniti tramite viti con testa di plastica avvitabili manualmente.
SFODERABILITÀ: in tessuto ed ecopelle è completamente sfoderabile. In pelle è parzialmente sfoderabile.
NOTE: poliuretano espanso privo di CFC.

MODULARITY: elements merged by screw with plastic head screwed manually.
COVER: completely removable in fabric and ecolather. Leather cover is partially removable.
NOTES: CFC-free polyurethane foam.

FIRMAMENTO 18

MATERASSO SPESSORE 18 CM PROFONDITÀ 195 CM
MATTRESS THICKNESS 18 CM DEPTH 195 CM

MATERASSI / MATTRESSES

FIRMAMENTO - VOLTA
FIRMAMENTO 18

BRACCIOLIO/ARMREST ERCOLE 20 CM

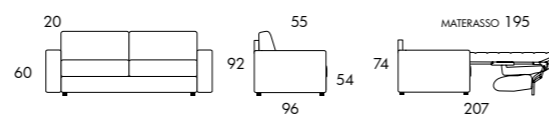
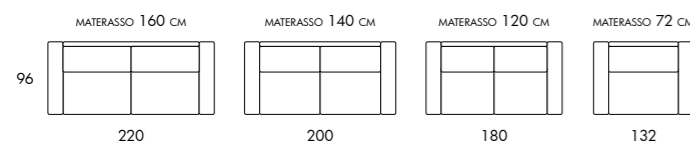

BRACCIOLIO/ARMREST AURIGA 17 CM

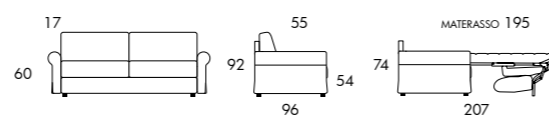
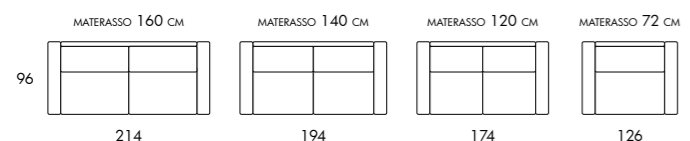

BRACCIOLIO/ARMREST DORADO 15 CM

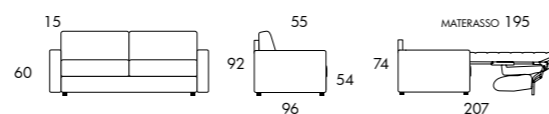
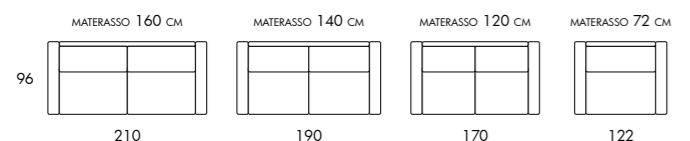

BRACCIOLIO/ARMREST LIRA 10 CM

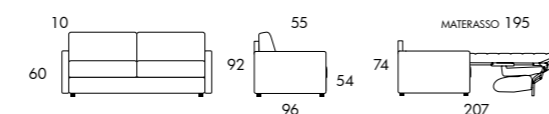
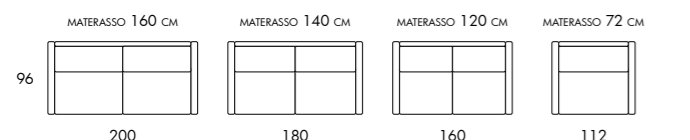

CUSCINO 50 x 50 CM
CUSHION 50 x 50 CM



CUSCINO 60 x 30 CM
CUSHION 60 x 30 CM



RISPETTO A "FIRMAMENTO" LE ALTEZZE VARIANO DI 7 CM - PER QUESTO MODELLO NON È DISPONIBILE LA VERSIONE COMPONIBILE
COMPARED TO "FIRMAMENTO" THE HEIGHTS INCREASES OF 7 CM - FOR THIS MODEL THE COMPOSITION VERSION IS NOT AVAILABLE

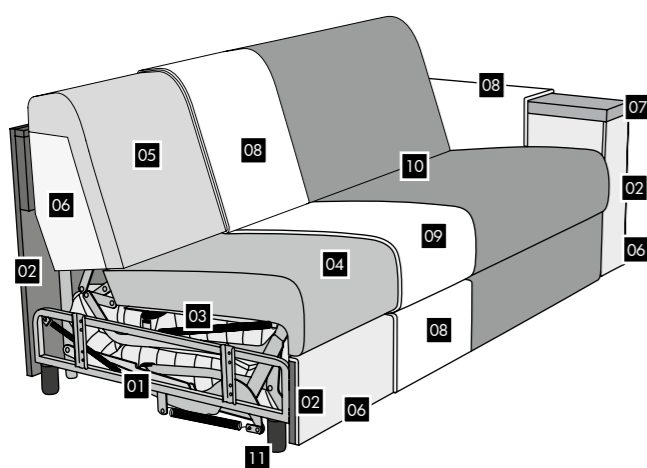

01. Struttura di acciaio ad alta resistenza con vernice protettiva di polveri epossidiche ~ High-strength steel structure with protective epoxy paint
02. Pannelli di particelle di pioppo, pannelli di stratificato di abete, massello di abete ~ Poplar chipboard wood, fir plywood, fir wood
03. Sostegno della seduta in rete elettro-saldata di acciaio ~ Seats supported by electro-welded steel net
04. PU espanso ds 30 kg/mc elastico ~ Elastic PU foam ds 30 kg/mc
05. PU espanso ds 25 kg/mc elastico ~ Elastic PU foam ds 25 kg/mc
06. PU espanso ds 21 kg/mc ~ PU foam ds 21 kg/mc
07. PU espanso ds 40 kg/mc elastico ~ Elastic PU foam ds 40 kg/mc
08. Fibra di PL da 150 gr termolegata a tessuto indemagliabile bianco ~ 150 gr PL fiber thermally coupled to white ladderproof fabric
09. Fibra di PL da 300 gr termolegata a fibra di PL agugliata ~ 300 gr PL fiber thermally coupled PL fiber needle-punched
10. Rivestimento ~ Cover
11. Piedi di faggio tinti noce medio, alto 8 cm ~ Feet made of beech stained walnut, 8 cm high.

SFODERABILITÀ: in tessuto ed ecopelle è completamente sfoderabile. In pelle è parzialmente sfoderabile.
NOTE: poliuretano espanso privo di CFC.

COVER: completely removable in fabric and ecoleather. Leather cover is partially removable.
NOTES: CFC-free polyurethane foam.

MATERASSO DI POLIURETANO ESPANSO DS 25 KG/MC
SPESSORE 14 CM PROFONDITÀ 195 CM
LARGHEZZE DISPONIBILI: 72 - 120 - 140 - 160 CM
RIVESTIMENTO DI COTONE
BORDATURA SU 1 LATO
DI SERIE SUI MODELLI **FIRMAMENTO E VOLTA**

POLYURETHANE FOAM MATTRESS DS 25 KG/MC
HEIGHT 14 CM DEPTH 195 CM
AVAILABLE WIDTHS: 72 - 120 - 140 - 160 CM
COTTON COVER
RIMMED ON 1 SIDE
AS STANDARD ON **FIRMAMENTO AND VOLTA**

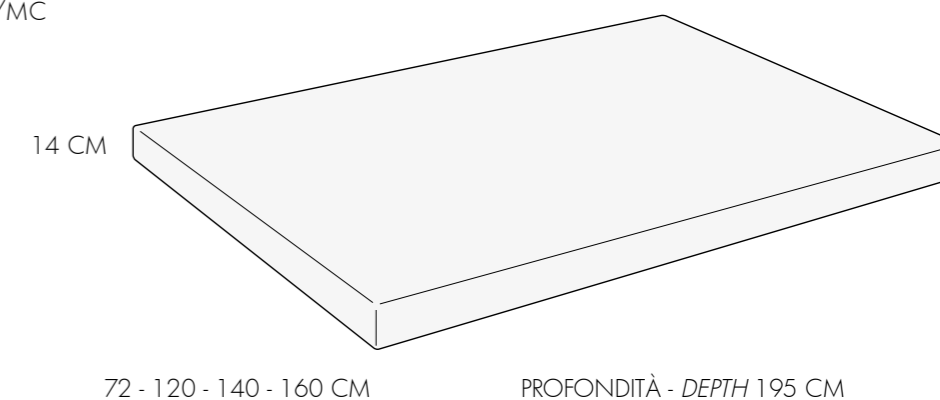

MATERASSO A MOLLE
SPESSORE 15 CM PROFONDITÀ 195 CM
LARGHEZZE DISPONIBILI: 72 - 120 - 140 - 160 CM
RIVESTIMENTO DI COTONE
BORDATURA SU 2 LATI
OPTIONAL SUI MODELLI **FIRMAMENTO E VOLTA**

SPRING MATTRESS
HEIGHT 15 CM DEPTH 195 CM
AVAILABLE WIDTHS: 72 - 120 - 140 - 160 CM
COTTON COVER
RIMMED ON 2 SIDES
OPTIONAL ON **FIRMAMENTO AND VOLTA**

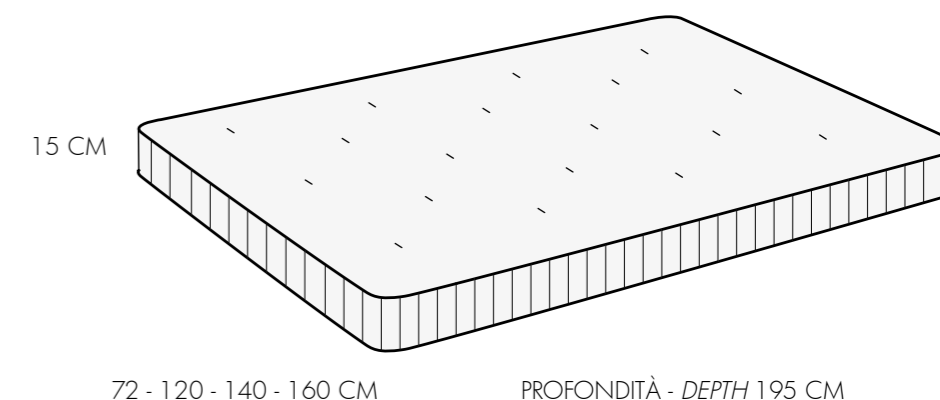

MATERASSO DI POLIURETANO ESPANSO DS 21 KG/MC
SPESSORE 18 CM PROFONDITÀ 200 CM
LARGHEZZE DISPONIBILI: 72 - 120 - 140 - 160 CM
RIVESTIMENTO DI COTONE
BORDATURA SU 2 LATI
DI SERIE SUL MODELLO **FIRMAMENTO 18**

POLYURETHANE FOAM MATTRESS DS 21 KG/MC
HEIGHT 18 CM DEPTH 200 CM
AVAILABLE WIDTHS: 72 - 120 - 140 - 160 CM
COTTON COVER
RIMMED ON 2 SIDES
AS STANDARD ON **FIRMAMENTO 18**

